

Article number: 204280M1260A0S

Description: E+G levelling foot

GN 42-80-M12-60-A0-S

Note: S Without nut, External hexagon at the bottom

Measures

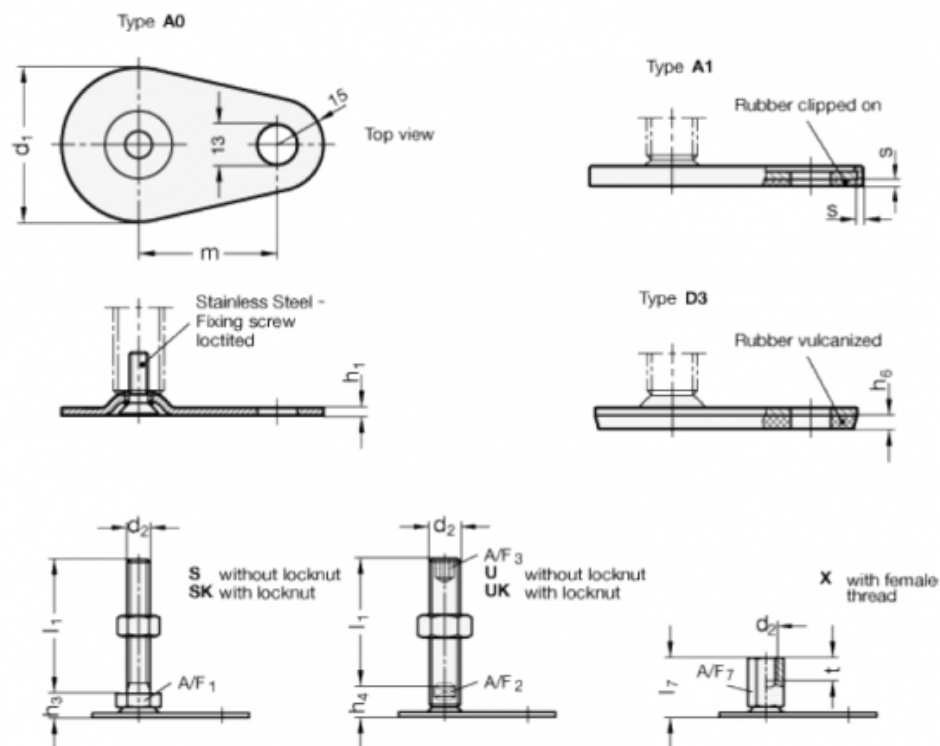

A/F1 = 17

d1 = 80

d2 = M12

h1 = 3

h3 = 12

h6 =

l1 = 60

m = 70

s =